

Clarke® PUMP



BOOSTER PUMP MODEL NO: BPT1200SS

PART NO: 7237006

OPERATION & MAINTENANCE INSTRUCTIONS



ORIGINAL INSTRUCTIONS

GC0922 - Rev 4

INTRODUCTION

Thank you for purchasing this CLARKE Booster Pump.

Before attempting to use this product, please read this manual thoroughly and follow the instructions carefully. In doing so you will ensure the safety of yourself and that of others around you, and you can look forward to your purchase giving you long and satisfactory service.

Upon receipt, any damage or deficiency should be reported to your CLARKE dealer immediately.

Keep these instructions in a safe place for future reference.

DESCRIPTION

The BPT1200SS is a centrifugal, horizontal, electric pumps with a self-priming capability and are designed with a venturi system, suitable for pumping water from up to 46 m height.

It is designed to operate with clean water only at a maximum temperature of 35°C. Operating with contaminated or salt water should be avoided. The inlet of the pump is higher than the inlet of the impeller so that the pump can start operating when only the body is filled with water.

The inlet side of the pump should always be fitted with a one-way valve to prevent water siphoning back out of the pump and to ensure the pump is always primed for the next start-up.

The pressure tank incorporates a butyl membrane, and a pressure controller provides automatic stop/start control. The pumps are supplied with a 1" BSP inlet filter with easy to clean replaceable elements. The transparent filter bowl allows for a visual check as to the condition of the filter cartridge.

GUARANTEE

This CLARKE product is guaranteed against faulty manufacture for a period of 12 months from the date of purchase. Please keep your receipt as proof of purchase. This guarantee is invalid if the product is found to have been abused or tampered with in any way, or not used for the purpose for which it was intended.

Faulty goods should be returned to their place of purchase. No product can be returned to us without prior permission. This guarantee does not effect your statutory rights.

SAFETY PRECAUTIONS



WARNING: AS WITH ALL MACHINERY THERE ARE CERTAIN HAZARDS INVOLVED WITH THEIR OPERATION AND USE. EXERCISING CAUTION WILL REDUCE THE RISK OF PERSONAL INJURY.

Please read all of the safety and operating instructions carefully before using this product.

WORK AREA

1. Keep the work area clean and well lit. Floors should always be kept clear. Cluttered or dark areas invite accidents.
2. Keep children and bystanders away while operating machines. Distractions can cause loss of control.

PERSONAL SAFETY

1. ALWAYS stay alert, watch what you are doing and use common sense when operating this pump. Do not use the pump while you are tired or under the influence of medication, drugs or alcohol. A moment of inattention can result in personal injury.
2. Do not over-reach. Keep your proper footing and balance at all times when positioning the pump.
3. Never direct the water discharge towards electrical wiring or equipment.
4. ALWAYS store the pump out of reach of children and do not allow persons unfamiliar with these instructions to operate it.
5. Never direct the discharge flow towards another person.
6. ALWAYS thoroughly familiarise yourself with this pump & its operation, and follow all instructions in this manual.
7. ALWAYS ensure that the pump is properly positioned to prevent it from moving during operation, and that the immediate area surrounding the pump is kept clear.

GENERAL EQUIPMENT USE AND CARE



WARNING: THE BPT600 & 1200SS ARE NOT SUBMERSIBLE PUMPS. ON NO ACCOUNT SHOULD THEY BE IMMERSSED IN WATER.

1. ALWAYS maintain the pump with care and keep it clean.

2. NEVER use this pump if any part is damaged. Have it inspected and repaired by your local Clarke dealer.
3. NEVER modify this pump in any way. Use it ONLY for the purpose for which it is designed.
4. NEVER run the pump dry. Always ensure the pump is filled or ready to be filled with water before starting.
5. NEVER overtighten drain or filler plugs. Excessive force may damage the threads and make the plug difficult to remove in future.
6. ALWAYS ensure the pump is in a horizontal position and is firmly anchored via its fixing screws to a level surface.
7. NEVER use for pumping flammable liquids or corrosive chemicals. These pumps are designed to pump WATER ONLY.
8. ALWAYS use a strainer connected to the suction (inlet) hose, to prevent stones and other solids from being drawn up, which could cause damage to the pump.
9. Switch the pump OFF immediately after the task is completed.

ELECTRICAL SAFETY

1. Electrical appliances must match the power outlet. Never modify the plug in any way. Do not use adaptor plugs with earthed (grounded) appliances. Correct plugs and outlets will reduce the risk of electric shock.
2. Do not abuse the electrical cable. Never use the cable for pulling or unplugging the heater. Keep the cable away from sources of heat, oil, sharp edges or moving parts. Damaged or tangled cables increase the risk of electric shock.
3. Keep the mains cable well away from machines and ensure an adequate electrical supply is close at hand so that the operation is not restricted by the length of the cable.
4. Always disconnect from the mains supply before moving the heater or performing any maintenance tasks.
5. Inspect the mains cable regularly for signs of damage. DO NOT use if it is damaged and always keep it away from the source of heat.
6. If the power cable is damaged, it must be replaced by the manufacturer, its service agent, or similarly qualified persons in order to avoid a hazard.
7. Do not use the pump if the switch does not turn it on and off. Any power product that cannot be controlled with the switch is dangerous and must be repaired.

8. Do not abuse the electrical cable. Keep the cable away from sources of heat, oil, sharp edges or moving parts. Damaged or tangled cables increase the risk of electric shock.

SERVICING

1. ALWAYS have the pump serviced by your local CLARKE dealer, using only identical replacement parts. This will ensure the safety of the pump is maintained. The use of non standard parts could be hazardous.
2. NEVER attempt any repairs yourself. If you have a problem with the pump contact your local CLARKE dealer.
3. ALWAYS turn the pump off before carrying out any maintenance.
4. Your CLARKE water pump has been designed to give long and trouble free service. If, however, having followed the instructions in this booklet carefully, you encounter problems, take the unit to your local CLARKE dealer.

ENVIRONMENTAL RECYCLING POLICY



By purchasing this product, the customer is taking on the obligation to deal with its safe disposal in accordance with the Waste Electrical and Electronic Equipment regulations (WEEE).

In effect, this means that this product must not be disposed of with general household waste. It must be disposed of according to the laws governing Waste Electrical and Electronic Equipment (WEEE) at a recognised disposal facility.

ELECTRICAL CONNECTIONS



WARNING: READ THESE ELECTRICAL SAFETY INSTRUCTIONS THOROUGHLY BEFORE CONNECTING THE PRODUCT TO THE MAINS SUPPLY.

Before switching the product on, make sure that the voltage of your electricity supply is the same as that indicated on the rating plate. This product is designed to operate on 230VAC 50Hz. Connecting it to any other power source may cause damage.

This product may be fitted with a non-rewireable plug. If it is necessary to change the fuse in the plug, the fuse cover must be refitted. If the fuse cover becomes lost or damaged, the plug must not be used until a suitable replacement is obtained.

If the plug has to be changed because it is not suitable for your socket, or due to damage, it should be cut off and a replacement fitted, following the wiring instructions shown below. The old plug must be disposed of safely, as insertion into a mains socket could cause an electrical hazard.

If the colours of the wires in the power cable of this product do not correspond with the markings on the terminals of your plug, proceed as follows.

- The **Blue** wire must be connected to the terminal which is marked **N** or coloured **Black**.
- The **Brown** wire must be connected to the terminal which is marked **L** or coloured **Red**.
- The **Yellow and Green** wire must be connected to the terminal which is marked **E** or  or coloured **Green**.

Plug must be BS1363/A approved.

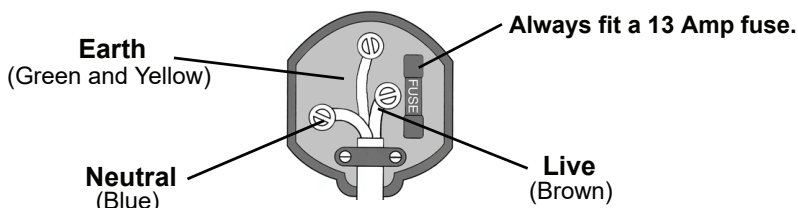

Ensure that the outer sheath of the cable is firmly held by the clamp

We strongly recommend that this machine is connected to the mains supply via a Residual Current Device (RCD)

If in any doubt, consult a qualified electrician. DO NOT attempt any repairs yourself.

PREPARATION FOR USE

Accessories designed specifically for this range of pumps are available from your nearest CLARKE dealer. Contact your dealer for further information.

IMPORTANT: The pump MUST NOT be connected to the mains electrical supply until all hose/pipe installation is completed.

CONNECTING THE INLET FILTER

1. Screw a non-return valve to the pump inlet ensuring it is the right way round, i.e., with the spring-loaded valve able to pass water in the direction of flow. Do not overtighten.
2. Screw the inlet filter onto the non-return valve and tighten by hand. Do not overtighten.

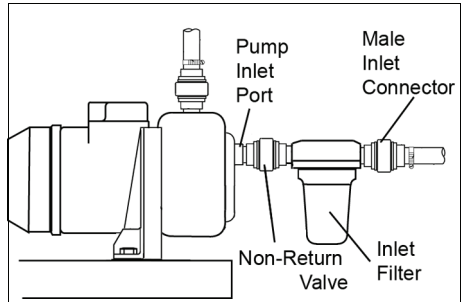

- Ensure the moulded arrow in the filter body which indicates the direction of flow, is pointing towards the pump and that the bowl is hanging vertically down. The filter bleed plug should be seen at the inlet side of the filter.

3. A male inlet connector is required which must be screwed into the filter inlet port and hand tightened.

POSITIONING THE PUMP

A typical installation of the pump is shown above. An air-tight seal is essential when connecting the suction and discharge hoses to the pump.

- Ensure there is no damage to the hoses which must be well protected and well supported.
- The pump must always be installed and operated in a horizontal position i.e. with the outlet port facing vertically upwards.
- The fixing holes in the feet should be used to secure the pump firmly in its operating position.
- Always ensure there is adequate air circulation around the pump motor.
- Avoid situations where the pump could become drenched with water. Neither the motor or terminal box are designed to be waterproof.

Position the pump as near to the water source as possible.

- Ensure there is adequate drainage and there is no risk of damage to property as a result of water being discharged.
- The performance of your pump will be affected by the diameter of the inlet pipe - any restriction will greatly reduce the flow. We strongly recommend that you use as large a pipe diameter as practical.
- A gate valve may be installed on the delivery (outlet) side of the pump which can be adjusted as required to regulate the flow of water and can also assist in priming the pump.



CAUTION: DO NOT PLACE ANY RESTRICTION ON THE SUCTION (INLET) SIDE OF THE PUMP UNLESS IT IS AN ISOLATOR VALVE IN A GRAVITY FED SYSTEM. THESE PUMPS SHOULD NOT BE OPERATED WITH THE DELIVERY VALVE COMPLETELY CLOSED.

- To prevent unnecessary strain or possible distortion to the pump, ensure that adequate support is provided to the hoses/pipes. They will be considerably heavier when filled with water.
- Where the pump is to be a permanent fixture, the fittings to the pump must be flexible, i.e. a short piece of hose should be installed between the rigid pipework and the pump.

IMPORTANT: An air leak in the suction line will prevent priming and reduce the capacity of the pump.

Pay particular attention to the following:

- a. Keep all hoses as short and straight as possible and avoid sharp bends.
- b. Ensure there is adequate drainage for the discharged water.
- c. If a flexible hose must be laid across a roadway, protect it with planking.

(Instantaneous shut off pressure, applied when a vehicle runs across an unprotected hose, could cause "hydraulic shock", which can damage the pump and/or the hose).

USING A FOOT VALVE/FILTER

Instead of using the pump for boosting an existing water supply, the pump may typically be used for drawing raw water from a well or excavation. In these applications a foot valve/coarse filter should be fitted to the lower end of the suction hose as illustrated on page 9. This will retain water in the suction system and more importantly, to prevent the possibility of large objects entering the pump body

1. Attach the foot valve to the end of the suction hose to prevent stones etc, from being drawn up, which could cause damage to the pump. Keep the foot valve clean. If it is likely to clog with dirt or debris, proceed by either:

- Preparing a bed of stones on which to rest the foot valve.
- Positioning the valve so that it stays clear of the bottom of the pit, pond or excavation.
- Tie the foot valve inside a basket or bucket.

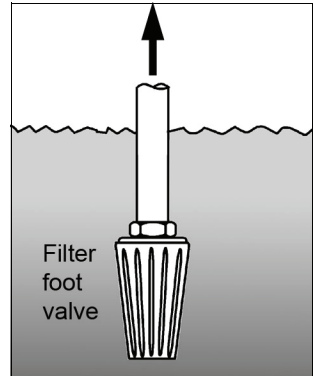

PREPARING THE BOOSTER PRESSURE TANK

These pumps utilise an air pressure tank with a pressure regulator to provide a constant pressure at the outlet. The pump will automatically cut in when the water pressure reduces to 1.5 Bar, and cut out when the pressure reaches 3 Bar. These pressures are factory set and must not be altered. The pump may continue to operate for a short while, after the tap is turned off, until the cut-out pressure is reached.

In order for the system to operate correctly, it is necessary to pressurise the air chamber to 1.5 Bar (22psi), which is carried out as follows

1. Unscrew the large protective cap on the end of the pressure tank to reveal the air valve as shown.
2. Use an airline or foot pump to pressurize the tank.
3. Check the pressure with a standard pressure gauge and replace the protective cap when completed.

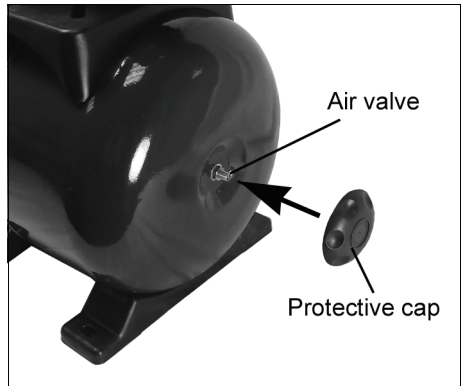

IMPORTANT: This procedure must be carried out before connecting to the water supply.

PRIMING THE PUMP

When suction lift is used to draw water into the pump it is essential that all connections and hoses are completely tight or the system will not work.

Although the pump is of the 'self-priming' type, it is still necessary to completely fill the inlet side of the pump with water prior to initial starting, or if the system has been drained for any other reason. Priming is carried out as follows.

1. Remove the filler plug on top of the pump and slowly fill with water until all air is expelled.
 - Refilling is necessary only if the pump has been drained or if the water has been lost. Never allow the pump to run dry.

2. Open any valve(s) fitted to the outlet side of the pump so as to ensure as great a flow as possible.

- If the inlet filter is being used, it is recommended that you remove the brass plug on top of the filter unit and fill the filter bowl with water.

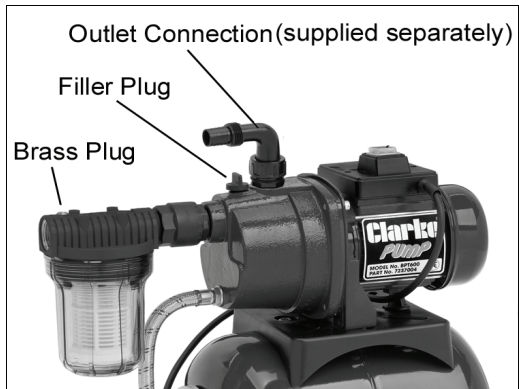

3. Switch on the pump and check for leaks. Water should start to flow through the system after a short while. If this does not happen, check to ensure that:

- the inlet pipe is completely secure and free from any defects.
- the pump body has been correctly primed.

OPERATION

1. Open any valves in the pipeline.
2. Connect the power supply and switch the pump ON.
3. Wait for the pump to prime.
4. If the motor fails to start or does not deliver water, refer to Faultfinding on page 12.

NOTE: Filling the suction pipe with water will speed up the priming process, and it is recommended that a non-return valve be fitted to the end of the suction pipe.

- If debris has entered the pump causing a blockage, the end housing can be taken off and the pump cleaned out as described under Maintenance on page 11.

NOTE: Contaminated water is water containing small solids in suspension, NOT slurry, sludge, sand, or mud.

5. Stop the pump by switching the pump OFF.

6. After use, drain residual water from the pump if there is danger of freezing. If the pump has been used with contaminated or salty water, it should be thoroughly flushed with clean water following use, both inside and out before replacing the plug.

MAINTENANCE

For any problems requiring the dismantling and overhaul of the pump, contact your CLARKE International Service Department on 020-8988-7400.

THE FILTER

The separate inlet filter (Part number 7175100) supplied with this pump will need regular cleaning out after use. Unscrew the filter bowl from the top section as shown and wash out the bowl and filter element with clean, soapy water.

CLEANING

The only other maintenance required is a regular inspection to ensure that nothing is blocking the passage of water through the pump.

If you suspect the pump is blocked by mud, silt, leaves etc, disconnect it from the mains power supply and backflush to clear any blockage.

Always keep the pump in a clean condition, checking regularly for loose bolts or a damaged power cable etc.

If the pump has been used under arduous conditions leading to internal fouling or damage, the end cover can be removed by undoing the four socket-headed cover bolts shown in Fig 6. The impeller can then be inspected for damage.

STORAGE

Store in a clean, dry environment protected from the weather.

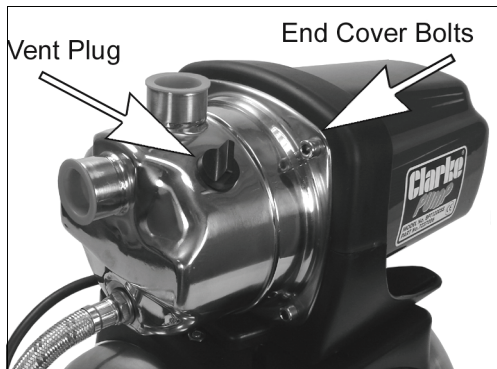

FAULTFINDING

Problem	Cause	Solution
Pump does not run	No mains supply.	Check power supply and replace fuse if necessary (check fuse rating)
	Impeller seized/blocked.	Disconnect pump from mains supply. Investigate cause and clear blockage
Pump fails to prime	Priming chamber not filled correctly.	Fill priming chamber leaving no air gap as described on page 9.
	Air leaks through suction hose joints (damaged hose, broken clamp, damaged/ill-fitting gasket).	Repair connections/replace hose as necessary.
	Blocked inlet hose.	Clean foot valve & ensure it is not submerged in mud/sediment etc. Ensure there are no kinks in the inlet hose.
Pump runs but gives poor output.	Inlet pipeline blockage.	Check inlet pipe and connector for leaks. Tighten as required.
	Inlet filter is blocked	Check and clean the foot valve.
	Impeller/mechanical seal is badly worn.	Return to Clarke dealer for repair.
	Congested material inside pump.	Dismantle pump and clean out.
	Impeller damaged and making poor seal.	Return to Clarke dealer for repair.
	Suction lift too high	Set pump as close as possible to the level of liquid being pumped.
	Suction or delivery pipeline obstructed.	Remove obstruction and ensure there are no kinks in the pipeline.

	Congestion in the suction line	Avoid unnecessary curves, restrictions or valves.
	Air leaks through damaged seal.	Renew seal.
Sudden loss of flow	Loose or leaking connection to inlet pipe.	Check pipeline and correct.
	Suction head is too high and causing cavitation.	Check suction head and lower the position of the pump.
Undue vibration or noise.	Suction head is too high and causing cavitation.	Check suction head and lower the position of the pump.
	Excessive flow of water	Adjust local regulator valve
	Resistance in inlet pipeline caused by obstruction.	Check pipe and leak out as necessary.
	Loose rotating component	Return to Clarke dealer for repair.
	Installation of pump not stable	Stop pump and re-position
	Air pocket in pump or pipeline	Release drain plug in impeller housing to release air.
	Damaged impeller	Return to Clarke dealer for repair.
Pump switches on and off repeatedly	Low air pressure	Check pressure.
	Membrane damaged	Return to Clarke dealer for repair.
Pump switches on and off when no water is being drawn.	Leak in output side.	Investigate and correct.
	Non-return valve faulty.	Check and rectify.
Pump does not switch off	Pressure switch faulty	Return to Clarke dealer for repair.
	No water at pump inlet	Check for blockage
	Damaged impeller	Dismantle and investigate.

TECHNICAL SPECIFICATIONS

Model	BPT1200ss
Weight	12.25 kg
Dimensions (L x W x H)	455 x 270 x 497
Max Rated Delivery	61 Litre/min
Max Head	46 m
Water Classification	Clean water (not suitable for drinking)
Connecting thread	1" BSP
Tank Capacity	19 Litre
Tank Rated Pressure	3 Bar
Operating Temperature	Max 35°C
Power Supply Required	230V @ 50Hz
Sound Pressure Level	73 dB LpA
Sound Power Level	83 dB LwA
Guaranteed Sound Power	<86 dB LwA

Please note that the details and specifications contained herein, are correct at the time of going to print. However, CLARKE International reserve the right to change specifications at any time without prior notice. Always consult the pump's data plate.

ACCESSORIES

A wide range of airline accessories is available, including Filters, Foot Valves, Hoses, Couplings, etc. Contact your Clarke dealer for further information or Clarke International Sales Department on 01992 565333.

The use of parts other than genuine Clarke replacement parts may result in possible safety hazards or decreased machine performance, and will invalidate your warranty.

The use of parts other than genuine CLARKE replacement parts may result in safety hazards, decreased performance, and will invalidate your warranty.

COMPONENT PARTS

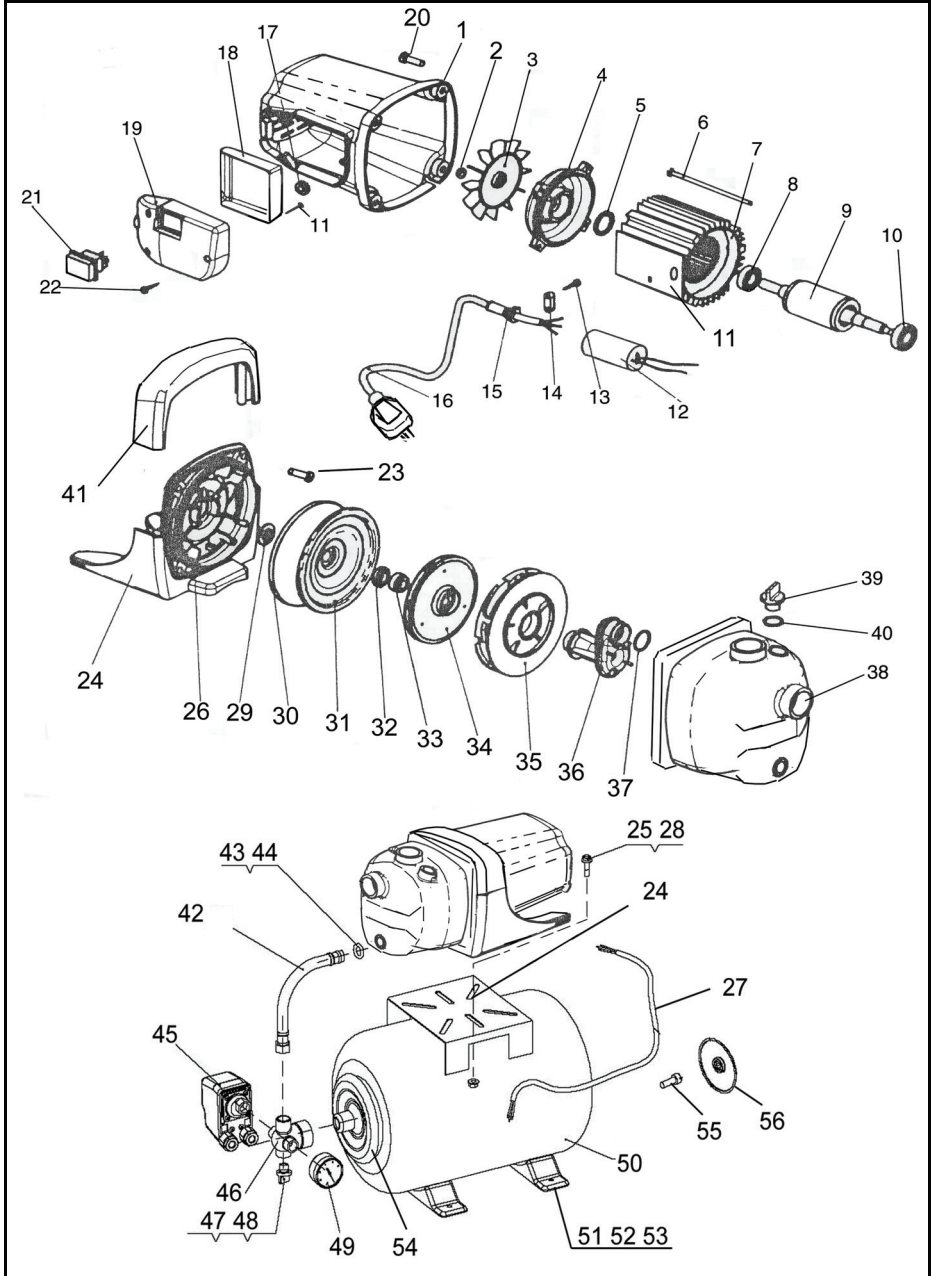

COMPONENT PARTS

ID	DESCRIPTION
1	Fan Cover
2	Retainer
3	Cooling Fan
4	Motor End Casting
5	Wave Washer
6	120mm Motor Tie Bolt
7	Motor Stator
8	Motor Bearing 6202-2Z
9	Rotor
10	Motor Bearing 6201-2Z
11	Motor Casting
12	Capacitor 12uF
13	Screw
14	Cable Clip
15	Cable Gland
16	Power Cable & Plug
17	Grommet
18	Switch Junction Box
19	Junction Box Cover
20	Machine Screw 10mm
21	Waterproof Switch
22	Self-tapping Screw
23	Allen headed bolt 20mm
24	Plastic Base
25	Shouldered Bolt M8
26	Frame Casting
27	Connecting Cable
28	Nut M8

ID	DESCRIPTION
29	Mechanical Seal
30	O-ring 140 dia
31	Diffuser Plate
32	Fixed Ring
33	O-ring
34	Impeller
35	Diffuser
36	Discharge Elbow
37	O-Ring 30 dia
38	End Housing
39	Threaded Plug 15mm
40	O-ring
41	Plastic Hood
42	Braided Hose
43	O-Ring
44	Middle Sealing Bush
45	Mechanical Pressure Switch
46	5-Way Connector
47	Drain Plug
48	O-Ring
49	Pressure Gauge
50	Pressure Tank
51	Plastic Foot
52	Nut M8
53	Washer
54	Connecting Flange
55	Air Inlet Valve
56	Protective Cover

DECLARATION OF CONFORMITY - UK

**UK
CA**

**Clarke®
INTERNATIONAL**

Hemnal Street, Epping, Essex, CM16 4UG

DECLARATION OF CONFORMITY

This is an important document and should be retained.

Product Description: Booster Pump, 19L (Stainless steel body)
Model number(s): BPT1200SS
Serial / batch Number: N/A
Date of Issue: 24/08/2022
(Noise Conformity)
Notified Body: TÜV SÜD Certification and Testing Co. Ltd
3-13F, No. 151 Heng Long Road
Shanghai 200070
China

Technical Documentation Holder: A.R. Pond
Clarke International
2a Shrubland Road
London E10 7RB
UK

Conformity Assessment Procedure: to 2000/14/EC Annex III & 2006/98/EC
Manufacturer: Clarke International
502W
Noise Related Value: 79.6dB
Measured Sound Power Level: 79.6dB
Guaranteed Sound Power Level: 80dB

BPT1200SS UKCA, Clarke, DOC 082422

Page 1 of 2

**Clarke®
INTERNATIONAL**

Hemnal Street, Epping, Essex, CM16 4UG

DECLARATION OF CONFORMITY

This is an important document and should be retained.

We hereby declare that this product(s) complies with the following statutory requirement(s):
Electromagnetic Compatibility Regulations 2016
Electrical Equipment (Safety) Regulations 2016
The Restriction of the Use of Certain Hazardous Substances in Electrical and Electronic Equipment Regulations 2012
Noise Emissions in the Environment by Equipment for use Outdoors Regulations 2001

The following standards have been applied to the product(s):
EN 55014-1:2017 + A11, EN 55014-2:2015, EN 61000-3-3:2013 + A1, EN IEC 61000-3-2:2019,
EN 60335-1:2012 + A11 + A13 + A1 + A14 + A2, EN 60335-2-41:2003 + A1 + A2, EN 62233:2008,
EN ISO 12100:2010, EK 927-12 Rev.2, IEC 62321-1:2013, IEC 62321-2:2013, IEC 62321-3-1:2013,
IEC 62321-4:2013 + AMD1:2017 CSV, IEC 62321-5:2013, IEC 62321-6:2013, IEC 62321-7-1:2015,
IEC 62321-7-2:2017, IEC 62321-8:2017, ISO 17075:2017, EN ISO 3744:1995

The technical documentation required to demonstrate that the product(s) meet(s) the requirement(s) of the aforementioned legislation has been compiled and is available for inspection by the relevant enforcement authorities.

The UKCA mark was first applied in: 2022

Signed:

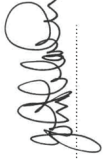

J.A. Clarke
Director

BPT1200SS UKCA, Clarke, DOC 082422

Page 2 of 2

DECLARATION OF CONFORMITY - CE



Clarke®
INTERNATIONAL

Fitzwilliam Hall, Fitzwilliam Place, Dublin 2

DECLARATION OF CONFORMITY

This is an important document and should be retained.

We hereby declare that this product(s) complies with the following directive(s):

2004/108/EC Electromagnetic Compatibility Directive.
2006/95/EC Low Voltage Equipment Directive.
2002/95/EC Restriction of Hazardous substances.
2000/14/EC Noise Emissions Directive (amended by 2005/68/EC).

The following standards have been applied to the product(s):

EN 56014-1:2017 + A11, EN 56014-2:2015, EN 61000-3-3:2013 + A1, EN IEC 61000-3-2:2019,
EN 60335-1:2012 + A11 + A13 + A1 + A14 + A2, EN 60335-2-41:2003 + A1 + A2, EN 62233:2008,
EN ISO 12100:2010, IEC 587-12 Rev.2, IEC 62321-1:2013, IEC 62321-2:2013, IEC 62321-3-1:2013,
IEC 62321-4:2013 + AMD1:2017 CSV, IEC 62321-5:2013, IEC 62321-6:2013, IEC 62321-7-1:2015,
IEC 62321-7-2:2017, IEC 62321-8:2017, ISO 17075:2017, EN ISO 3744:1995

The technical documentation required to demonstrate that the product(s) meet(s) the requirement(s) of the aforementioned directive(s) has been compiled and is available for inspection by the relevant enforcement authorities.

The CE mark was first applied in: 2007

Signed:

J.A. Clarke
Director

BPT1200SS CE Clarke DDC 08242

Page 2 of 2



Clarke®
INTERNATIONAL

Fitzwilliam Hall, Fitzwilliam Place, Dublin 2

DECLARATION OF CONFORMITY

This is an important document and should be retained.

Product Description:

Booster Pump 19L (Stainless steel body)

Model number(s):

BPT1200SS

Serial / batch Number:

N/A

Date of Issue:

24/08/2022

(Noise Conformity)

Notified Body:

TUV SUD Certification and Testing Co. Ltd
3-13F, No. 151 Heng Tong Road
Shanghai 200070
China

Technical Documentation Holder:

A.R. Pond
Clarke International
2a Shrubland Road
London E10 7RB
UK

Conformity Assessment Procedure:

to 2000/14/EC Annex III & 2005/68/EC

Manufacturer:

Clarke International

Noise Related Value:

602W

Measured Sound Power Level:

79.6dB

Guaranteed Sound Power Level:

80dB

BPT1200SS CE Clarke DDC 08242

Page 1 of 2

NOTES

A SELECTION FROM THE VAST RANGE OF

Clarke®

QUALITY PRODUCTS



AIR COMPRESSORS
From DIY to industrial, Plus air tools, spray guns and accessories.

GENERATORS
Prime duty or emergency standby for business, home and leisure.

POWER WASHERS
Hot and cold, electric and engine driven - we have what you need

WELDERS
Mig, Arc, Tig and Spot.
From DIY to auto/industrial.

METALWORKING
Drills, grinders and saws for DIY and professional use.

WOODWORKING
Saws, sanders, lathes, mortisers and dust extraction.

HYDRAULICS
Cranes, body repair kits, transmission jacks for all types of workshop use.

WATER PUMPS
Submersible, electric and engine driven for DIY, agriculture and industry.

POWER TOOLS
Angle grinders, cordless drill sets, saws and sanders.

STARTERS/CHARGERS
All sizes for car and commercial use.



PARTS & SERVICE: 0208 988 7400

Parts Enquiries
Parts@clarkeinternational.com

Servicing & Technical Enquiries
Service@clarkeinternational.com

SALES: UK 01992 565333 or Export 00 44 (0)1992 565335

Clarke INTERNATIONAL Hemnall Street, Epping, Essex CM16 4LG
www.clarkeinternational.com